



Peso medio
Mittlere gewicht

Dati tecnici . Technische Daten

Quote espresse in mm - Maßangaben in mm

Vista laterale . Seitenansicht

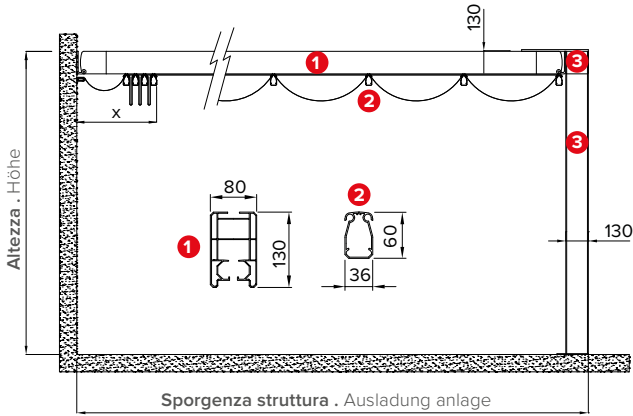

Pendenza telo min. 3% . Mindestgefälle Tuch 3%.

Vista frontale . Vorderansicht

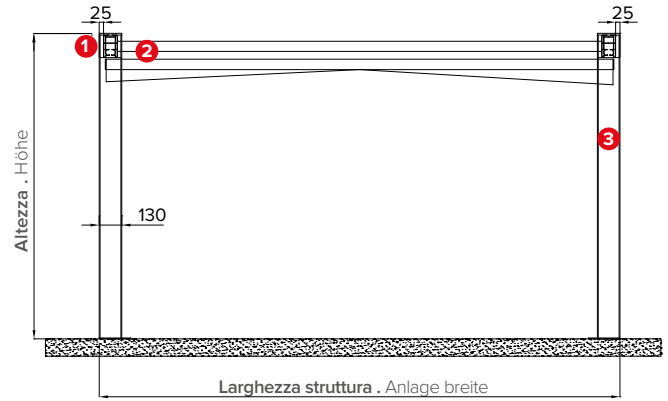

Vista dall'alto . Draufsicht

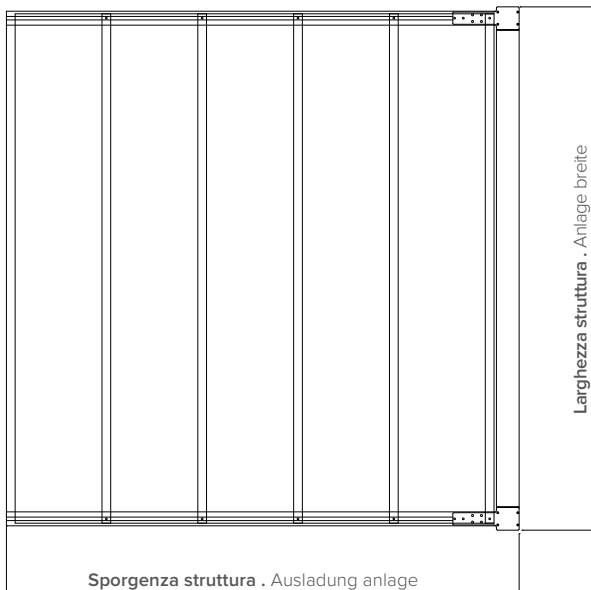

Altezza piantana 13 x 13 cm garantita, H 250 cm, oltre, chiedere fattibilità . Garantierte Stützhöhe 13 x 13 cm, H 250 cm, Machbarkeit bitte erfragen.

Sporgenza Ausladung	S cm	200	250	300	350	400	450	500	550	600
Frangitratta indicativi Zwischenelemente indikativen	n°	4	5	6	7	8	9	10	11	12
Impacchettamento Verpackung	X cm	47	52	57	62	67	72	77	82	87



Dettagli tecnici . Technische Details

Quote espresse in mm - Maßangaben in mm

Piantana . Stütze

Piede a terra . Standfuß

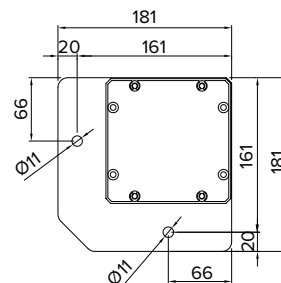
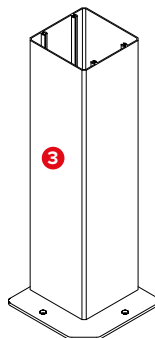
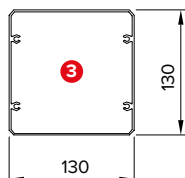

Dettaglio tettuccio . Detailansicht des Schutzdaches
033-977 / 033-978

Staffa attacco parete
Bügel für Wandbefestigung

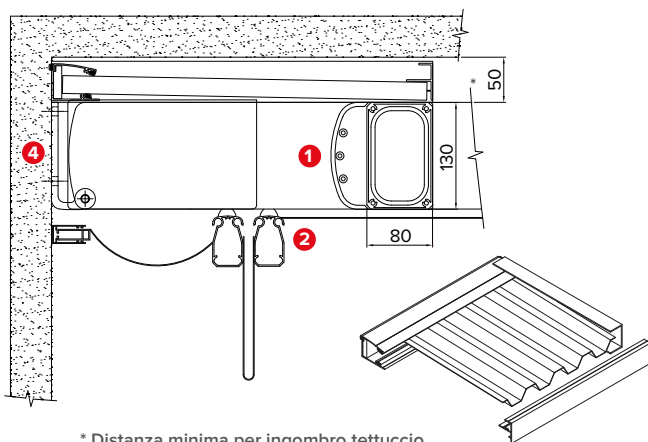

* Distanza minima per ingombro tettuccio
Mindestabstand für Schutzdach

Profili perimetrali in alluminio estruso e supporto frontale 13x8cm.
Umfangsprofile aus extrudierte Aluminium und Frontstütz von cm. 13x8.

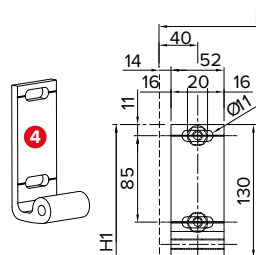

Legenda tecnica . Technische Legende

- 1 Guida . Führung
- 2 Frangitratta . Zwischenelement
- 3 Piantana . Stütze
- 4 Staffa attacco parete . Bügel für Wandbefestigung

X Impacchettamento . Verpackung