

# R152 PERGOSQUARE



Peso medio  
Mittlere gewicht

## Dati tecnici . Technische Daten

Quote espresse in mm - Maßangaben in mm

Vista laterale . Seitenansicht

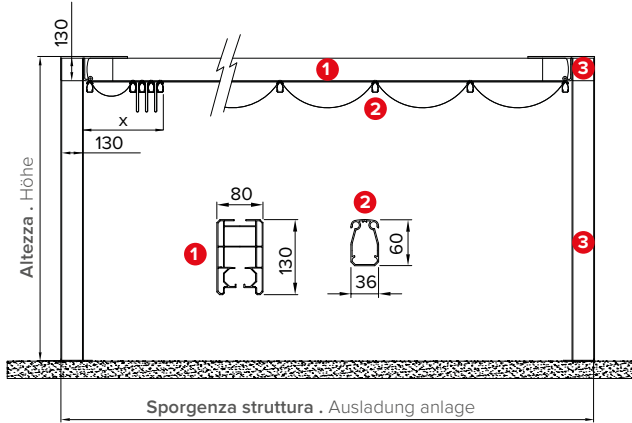

Pendenza telo min. 3% . Mindestgefälle Tuch 3%.

Vista frontale . Vorderansicht

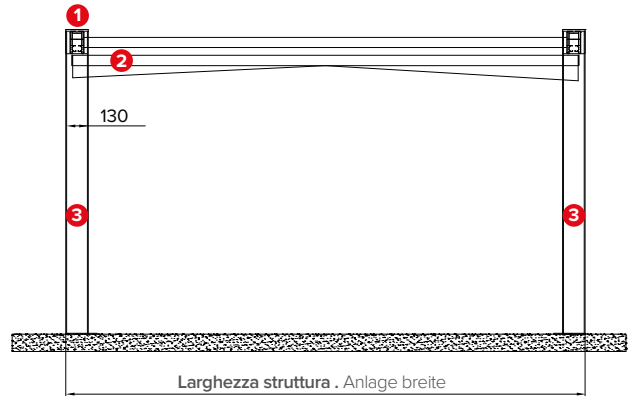

Vista dall'alto . Draufsicht

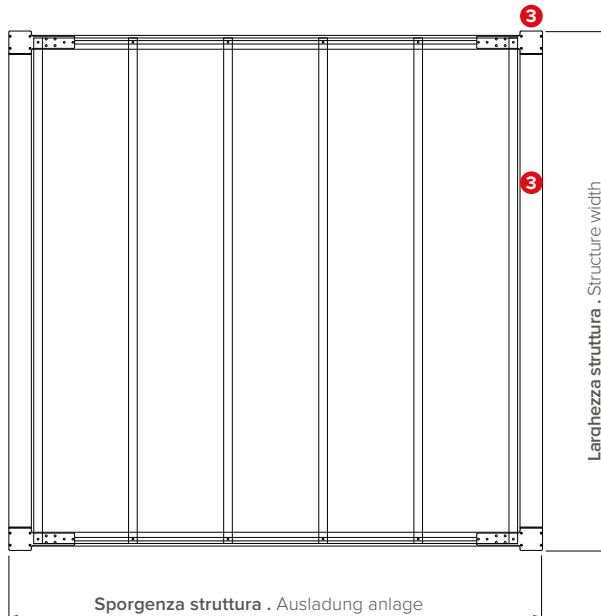

Altezza piantana 13 x 13 cm garantita, H 250 cm, oltre, chiedere fattibilità . Garantierte Stützhöhe 13 x 13 cm, H 250 cm, Machbarkeit bitte erfragen.

<b>Sporgenza</b> Ausladung	<b>S cm</b>	200	250	300	350	400	450	500	550	600
<b>Frangitratta indicativi</b> Zwischemente indikativen	<b>n°</b>	4	5	6	7	8	9	10	11	12
<b>Impacchettamento</b> Verpackung	<b>X cm</b>	47	52	57	62	67	72	77	82	87



## Dettagli tecnici . Technische Details

Piantana . Stütze

Piede a terra . Standfuß

Quote espresse in mm - Maßangaben in mm

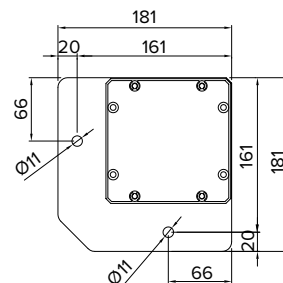
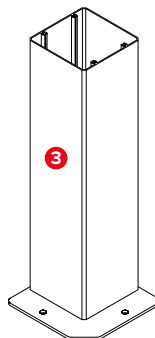
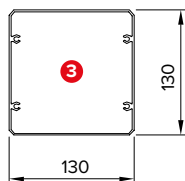

Dettaglio tettuccio . Detailansicht des Schutzdaches  
033-990 / 033-991

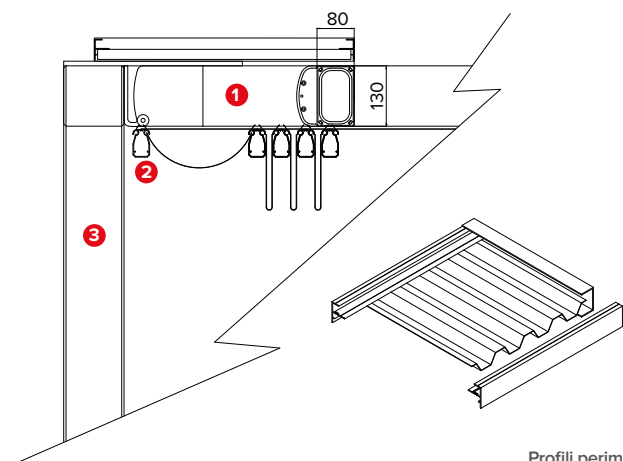

Profili perimetrali in alluminio estruso e supporto frontale 13x8cm.

Umfangsprofile aus extrudierte Aluminium und Frontstütz von cm. 13x8.

PIANE E AUTOPORTANTI  
EBENE UND SELBSTTRÄGENDE

## Legenda tecnica . Technische Legende

- 1 Guida . Führung
- 2 Frangitratta . Zwischenelement
- 3 Piantana . Stütze

X Impacchettamento . Verpackung